

TE

HP 15-30

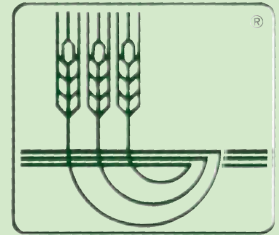

SOVEMA
S.p.A.



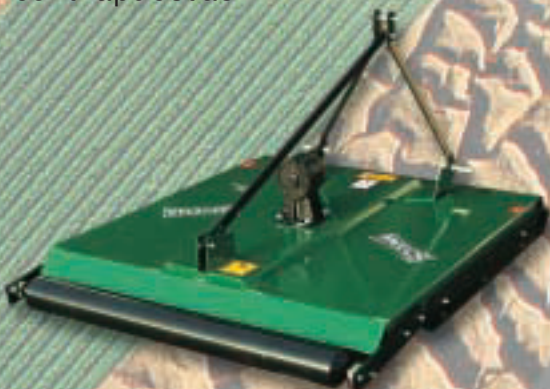

- TE, for compact tractors, is especially designed for grass cutting. Cutting by swinging knives.
- Le TE est un taille-herbe pour des tracteurs de petites puissances, pratique, versatile et léger. La machine est destinée à la coupe et au broyage de l'herbe. L'élément final de travail est composé d'une barre avec deux couteaux amovibles.
- Il TE è per trattori di piccole potenze, pratico, versatile, leggero. Specificatamente destinato al taglio ed alla trinciatura dell'erba. L'elemento terminale di lavoro è composto da una barra rotante con due coltelli contrapposti.
- Für kleine Traktoren entworfen, ist das TE Mähwerk praktisch, vielseitig und von geringem Gewicht. Die Arbeitswerkzeuge sind ein Paar Messer an einem Spindelende.
- La TE es para tractores de pequeña potencia, práctica, versátil y ligera. Especificamente destinada para el corte y el trinchado de la hierba. El elemento terminal de trabajo está compuesto por una barra giratoria con dos cuchillas contrapuestas.





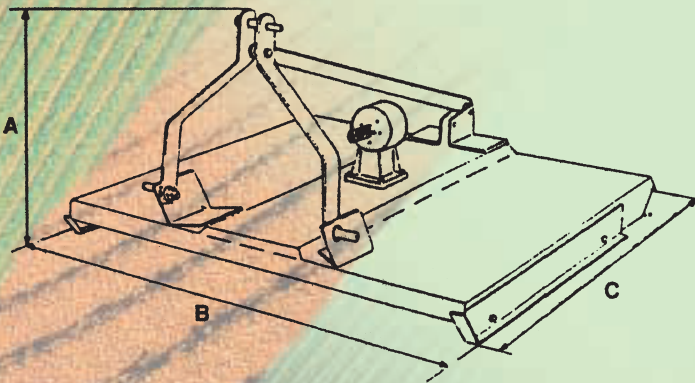

cutter
taille-herbe
trinciaerba
mähwerk
trincha-hierba

- High suction blades (13) produce an even cut and excellent air-flow to disperse cutting completely.
- Les couteaux avec ailette (13), pour les tracteurs à prise de force horaire, permettent une forte ventilation et consentent à l'herbe taillée de sortir parfaitement du carter, tenant propre le périmètre de rotation des couteaux.
- Gli utensili a coltelli con aletta (13), per trattori con P.T.O. a rotazione oraria, permettono una forte ventilazione e consentono all'erba tagliata di fuoriuscire perfettamente dal telaio, mantenendo pulita l'area di rotazione dei coltelli.
- Die Flügelmesser (13), für Traktoren mit in Uhrzeigersinn drehender Zapfwelle, entwickeln eine starke Ventilation, die das Schnitgut sauber aus der Arbeitszone befördern.
- Las cuchillas con aleta (13), para tractores con toma de fuerza de giro horario, generan una fuerte ventilación y permiten a la hierba cortada salir perfectamente del cárter, manteniendo limpia la zona de rotación de las cuchillas.



MOD.			13
	cm	inches	n.
TE	4÷12	2"÷5"	2

MOD.								A		B		C	
	cm	inches	HP	rpm	rpm	Kg.	Lbs.	cm	inches	cm	inches	cm	inches
TE 100	100	40"	15	540	1040	135	295	79	31"	106	42"	116	46"
TE 130	130	51"	20	540	1040	170	375	79	31"	141	56"	146	57"
TE 150	150	60"	30	540	1040	198	435	79	31"	155	62"	160	64"

Technical data are subject to change and not binding.



SOVEMA SpA
Via Olmo 6 - I-41010 Coggio di Piano - Italy
Phone +39 059 938512
Fax 059 938512
E-MAIL: sovema@sovema.com
WEB site: http://www.sovema.com
Factories: Coggio di Piano - Arzago

SOVEMA Inc.
1937 Vanderhorst Dr.
Memphis TN 38134
Phone 901388 8869
Fax 901388 8348
E-MAIL: sovema@sovemausa.com
WEB site: http://www.sovemausa.com

SOVEMA CANADA LTD
4845 Portage Avenue
Headingley, Manitoba R4H 1C7
Phone 204 895 9042
Fax 204 897 6975
E-MAIL: sovema@sovemacanada.com
WEB site: http://www.sovemacanada.com