

INSTRUCTION MANUAL



C/RE/C-2

ROTARY TILLER

CONGRATULATIONS

Dear Owner,

Thank you for buying a SOVEMA manufactured product.

Your new machine is carefully designed and manufactured to give you superior performance and dependable service, if properly operated and maintained.

You will find this machine to be rugged and reliable when matched to the suggested horsepower operating range.

Much time has been invested in providing safety and protection. Please carefully read this manual. It tells you how to safely and easily assemble, operate and maintain your machine.

Be sure that you and any other operator carefully follow the recommended safety practices at all times. Failure to do so could result in personal injury or property damage.

Of course, if you should ever have any problems or questions, please contact your local SOVEMA dealer or contact us at the addresses or numbers indicated in this manual.

SOVEMA manufactures a variety of innovative equipment. If you are interested in reviewing our full line, please contact us.

Thanks for your choice.

Ginettino Mayer
President

TABLE OF CONTENTS

- SYMBOLS	Page 3
- GENERAL INFORMATION	Page 4
- SAFETY AND WARNING DECALS	Page 5
- SAFETY INSTRUCTIONS	Page 7
- MAIN CHECK	Page 10
- TECHNICAL SPECIFICATIONS	Page 11
- ATTACHING THE MACHINE TO THE TRACTOR	Page 14
- DEPTH CONTROL	Page 18
- BEGINNING WORK	Page 21
- TROUBLE SHOOTING	Page 22
- DISCONNECTING THE MACHINE FROM THE TRACTOR	Page 24
- STORING OF THE MACHINE	Page 25
- MAINTENANCE	Page 26
- TOXICOLOGICAL INFORMATION	Page 29
- PARTS LIST	Page 31
- WARRANTY POLICY	Page 40
- SOVEMA PRODUCT LINE	Page 44

SYMBOLS

These symbols appear throughout the manual.
Remember their meaning and advice.



**MEANS: CAUTION!
YOUR SAFETY IS INVOLVED**

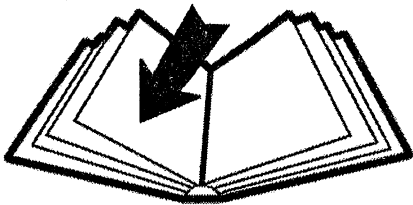

MEANS: READ CAREFULLY

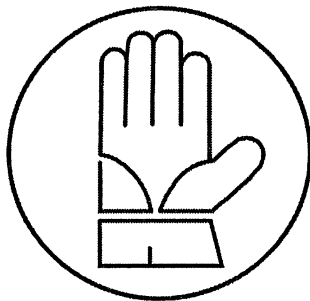

MEANS: USE PROTECTIVE GLOVES

GENERAL INFORMATION

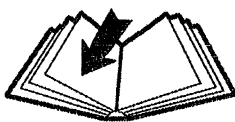

All implements with moving parts are potentially hazardous. The manufacturer has designed the implement to be used with all the safety equipment properly attached. The purpose of this manual is to assist you in safety maintaining and operating the implement.

These instructions have been compiled from our experience. Through this experience and these instructions, you should be able to develop operating procedures suitable to your particular situation.

Illustrations and data used in this manual may vary slightly in some details. Throughout this manual references are made in left and right directions. These are determined by standing at the rear of the equipment and facing the direction of forward travel.

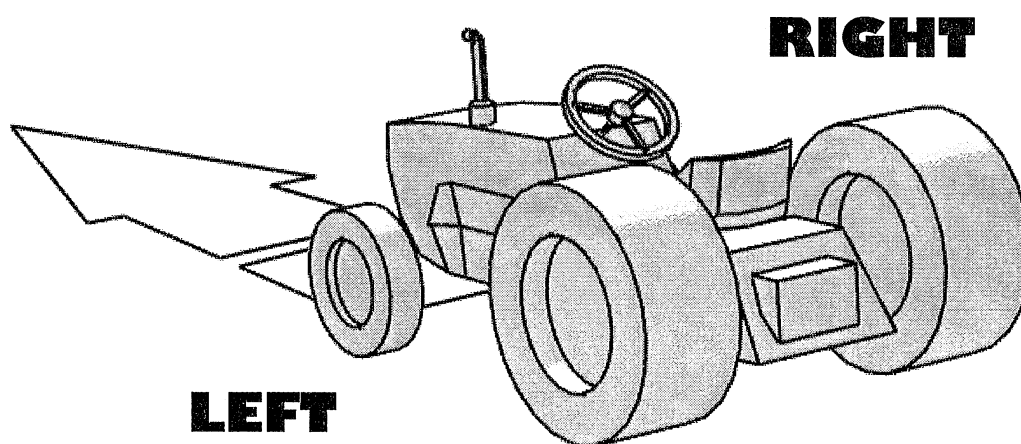

Even if some illustrations in this manual show the machine with safety shields removed for a better view, never operate in these conditions.

BEFORE OPERATING THE IMPLEMENT, ALL SAFETY SHIELDS OR DEVICES MUST BE MOUNTED

SAFETY AND WARNING DECALS

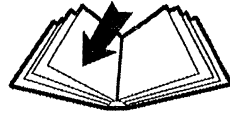

Safety decals on the implement contain important safety warning messages. To prevent injuries we invite the operator to read them carefully and keep them clear. Check that all the decals are on the machine. If not, **DO NOT USE** the machine and report to the Dealer immediately to get the decals. Decals on the machine are the following and mean:

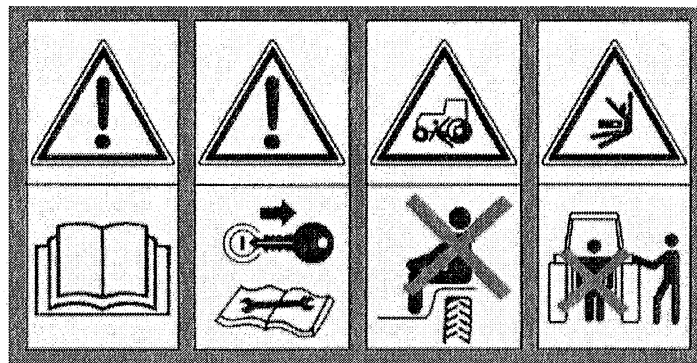

1

2

3

4



1. Before operating the equipment, read carefully the operator's manual.



2. Before maintenance operation, lower the implement, shut off the engine and read the operator's manual.



3. Do not allow riders on tractor or implement.



4. Do not stand behind the tractor during the operations.

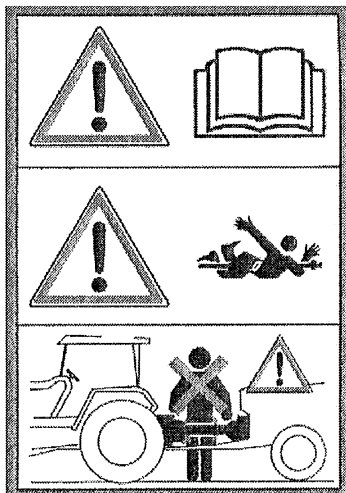

5. Before operating the equipment, read carefully the operator's manual.



6. DANGER! Entanglement of driveline..



7. KEEP AWAY from driveline in operation: contact can cause death!

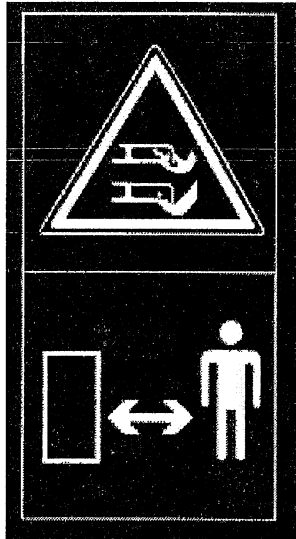

8



8. Danger. Your hands and feet can be injured by moving parts. Keep away from the implement.



9. Danger. Your feet can be injured. Keep away from the implement.

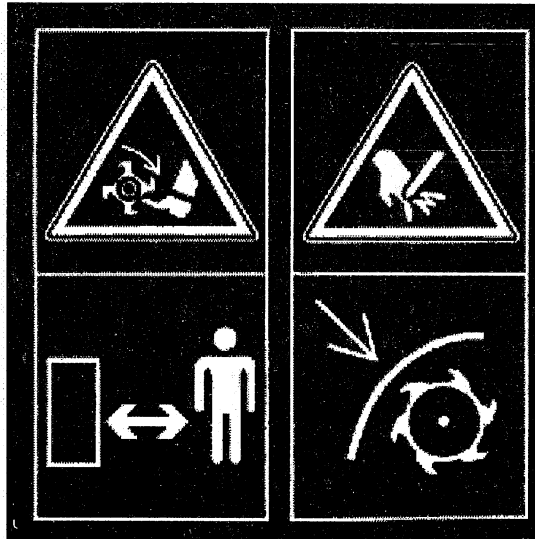

9

10



10. Danger. Your hands can be injured. Do not remove safety protection and keep away from moving parts.



11. Danger. Your hands can be injured. Do not remove the cover and keep away from moving parts.



11



12. The machine is designed for use on tractors with 540 RPM PTO only.

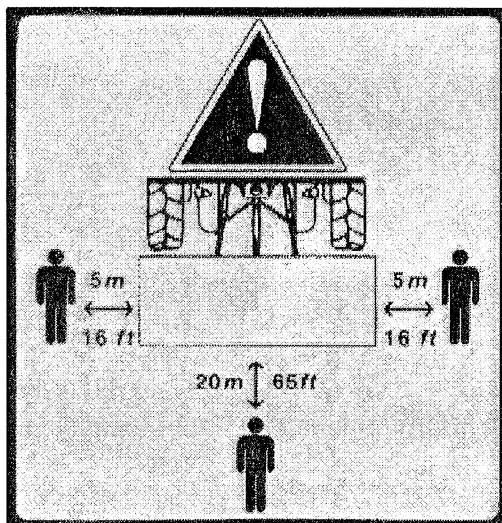

13. Caution! During working operations all bystanders must stay beyond the shown distances from the implement.

SAFETY INSTRUCTIONS



Before using the implement you must be sure to know the main safety precautions; in fact many accidents are caused by not observing these rules.

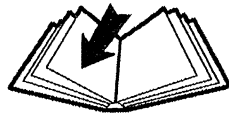

Pre-operational and operational safety rules



Make sure that no person operates this machine unless they first, thoroughly read and studied the operator instructions for this machine and understood all the safety precautions.



Keep all guards, shields and safety decals in place and proper working order before operating this machine.



Operate only with a tractor equipped with an approved Roll Over Protective System (ROPS) and always wear your seat-belt.



Operate only in daylight or good artificial light.



Only trained personnel can operate with the tractor and the implement.



Personal protection equipment, including safety shoes, safety glasses, hard hat and gloves are recommended during the different operations. Do not allow long hair, loose fitting clothing or jewellery to be around moving parts.



Do not leave the tractor seat until the engine is completely **turned off, brakes locked** and **ignition key removed**.



Do not allow riders on the machine or tractor at any time. No safe place for any rider.



Before starting to operate, be sure that the tractor's PTO is set to match the PTO requirements of the implement. The speed is indicated in this manual and on the implement.



Do not use different driveline . Always use type and size supplied by the manufacturer.



Make sure driveline spring-activated locking pin operate freely and are seated firmly in tractor PTO stub shaft groove.



For engaging or disengaging the tractor PTO, refer to your tractor manual.



Connect and disconnect PTO shaft only when tractor engine is turned off.



Keep hands, feet, hair and clothing away from moving parts.



To prevent injury by thrown objects DO NOT operate unless all personnel, livestock and pets are 20 m (65 ft) away.



The rotating parts of the machine have been designed and tested for rugged use. However they could fail upon impact with heavy solid objects. Such impact could cause the broken objects to be thrown outward at very high speed. To reduce the possibility of serious injury, or even death, never allow the rotating parts to contact such obstacles.



Stop the machine and tractor immediately upon striking an obstruction. Turn engine off, remove key, inspect and repair any damage before resuming operation.



No repairs or adjustments should be attempted while the machine is attached to a tractor that is turned on.



Working inclination of PTO driveline must not exceed 25° (see fig.1). Working angles greater will damage the PTO and serious personal injury could occur as well.

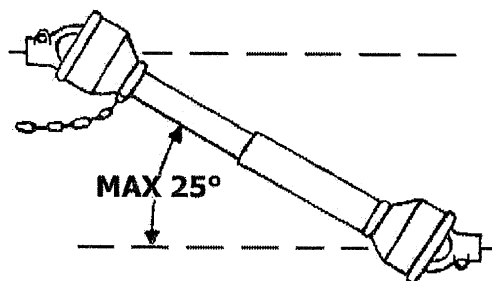

Disengage tractor PTO and place transmission in to neutral before attempting to start engine.

Transport safety



Plan your route to avoid heavy traffic.



For public roads, comply with state and local safety and movement rules.



Be sure that the implement is in the raised position for transport.



When you must drive, do not drink.



Pay attention to traffic when operating near or crossing roadways.



Reduce speed when transporting mounted implement to avoid bouncing and loss of steering control.



Pay attention when you turn curves or you go up and down on hills with the implement. Be sure that at least 25% of the tractor's weight is on the front wheels to maintain safe steering. Drive at a low speed.



NEVER allow riders on implement or tractor. Falling off can kill.



Be a safe and courteous driver.

Maintenance safety



Good maintenance is your responsibility. Poor maintenance is an invitation to trouble.

For maintenance follow these common practises:



- keep service area clean;
- use adequate illumination for the job;
- be sure tools and electrical outlets are properly grounded;
- make sure there is plenty of ventilation.



Before making maintenance on this machine, drive to a level area, disengage the PTO, lower the machine, turn off the engine, set the brakes and remove the ignition key.



Keep all persons away from operator control area while performing maintenance.



ALWAYS use personal protection devices.



Periodically tighten all bolts, nuts and screws.



The implement manufacturers assume no liability if replacement parts other than the original factory parts are used.



After servicing, be sure that all safety shields are re-installed properly.



Be sure that all safety decals are installed, clean and in good condition.



If the machine is modified from the original design, no responsibility for the manufacturer can be claimed.

MAIN CHECK LIST

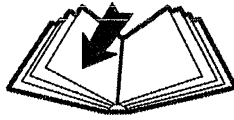

Before connecting the machine to the tractor, read the following instructions:

- Be sure the weight and power of the tractor is correct with the machine you want to connect. If you have any doubt, see the technical specifications.



- Ensure that all safety decals are properly installed and clean.
- Check oil in the gearbox. With low oil, gears get damaged.
- Be sure that all safety shielding is properly installed and in good condition.

TECHNICAL SPECIFICATIONS

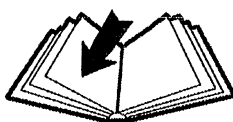

The machines described in this manual are the **RE-2**, **CRE-2**, **REC-2** and **CREC-2** series.

MOD.	Working width		Working positions		HP	Pto (rpm)	Rotor (rpm)
	cm	inches	Sx cm/inches	Dx cm/inches			
RE-2 120 S	120	48"	55/22"	65/26"	30 - 50	540	223
RE-2 140 S	140	56"	65/26"	75/30"	40 - 60	540	223
RE-2 160 S	160	64"	75/30"	85/34"	45 - 65	540	223
RE-2 180 S	180	72"	85/34"	95/38"	50 - 80	540	223
RE-2 200 S	200	80"	100/40"	100/40"	55 - 80	540	223
RE-2 220 S	220	88"	100/40"	115/46"	60 - 85	540	223

RE-2 140 R	140	56"	65/26"	75/30"	40 - 60	540	223
RE-2 160 R	160	64"	75/30"	85/34"	45 - 65	540	223
RE-2 180 R	180	72"	85/34"	95/38"	50 - 80	540	223
RE-2 200 R	200	80"	100/40"	100/40"	55 - 80	540	223
RE-2 220 R	220	88"	100/40"	115/46"	60 - 85	540	223

CRE-2 180 S	180	72"	85/34"	95/38"	50 - 80	540	223
CRE-2 200 S	200	80"	100/40"	100/40"	55 - 80	540	223
CRE-2 220 S	220	88"	100/40"	115/46"	60 - 85	540	223

CRE-2 180 R	180	72"	85/34"	95/38"	50 - 80	540	223
CRE-2 200 R	200	80"	100/40"	100/40"	55 - 80	540	223
CRE-2 220 R	220	88"	100/40"	115/46"	60 - 85	540	223

MOD.	Working width		Working positions		HP	Weight	
	cm	inches	Sx cm/inches	Dx cm/inches		Kg	Lbs
REC-2 120 S	120	48"	55/22"	65/26"	30 - 50	325	715
REC-2 140 S	140	56"	65/26"	75/30"	40 - 60	370	814
REC-2 160 S	160	64"	75/30"	85/34"	45 - 65	425	935
REC-2 180 S	180	72"	85/34"	95/38"	50 - 80	465	1023
REC-2 200 S	200	80"	100/40"	100/40"	55 - 80	490	1078
REC-2 220 S	220	88"	100/40"	115/46"	60 - 85	550	1210

REC-2 140 R	140	56"	65/26"	75/30"	40 - 60	460	1012
REC-2 160 R	160	64"	75/30"	85/34"	45 - 65	510	1122
REC-2 180 R	180	72"	85/34"	95/38"	50 - 80	560	1232
REC-2 200 R	200	80"	100/40"	100/40"	55 - 80	590	1298
REC-2 220 R	220	88"	100/40"	115/46"	60 - 85	630	1386

CREC-2 180 S	180	72"	85/34"	95/38"	50 - 80	515	1140
CREC-2 200 S	200	80"	100/40"	100/40"	55 - 80	540	1190
CREC-2 220 S	220	88"	100/40"	115/46"	60 - 85	600	1330

CREC-2 180 R	180	72"	85/34"	95/38"	50 - 80	725	1595
CREC-2 200 R	200	80"	100/40"	100/40"	55 - 80	770	1694
CREC-2 220 R	220	88"	100/40"	115/46"	60 - 85	850	1870

By order it is possible to equip the **RE-2**, **CRE-2**, **REC-2** and **CREC-2** series of a gear transmission instead of a chain transmission (see fig. 1).

For the **RE-2** and **CRE-2** series the rotor regime would go from **223 rpm** to **238 rpm**.

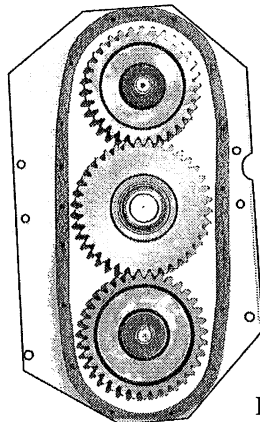

FIG. 1

SPEED CHART FOR REC-2 AND CREC-2 SERIES EQUIPPED WITH CHAIN TRANSMISSION.

Gear Ratio		PTO	Rotor
A	B	R.p.m.	R.p.m.
21	18	540	191
20	19	540	212
19	20	540	235
18	21	540	260

SPEED CHART FOR REC-2 AND CREC-2 SERIES EQUIPPED WITH GEAR TRANSMISSION.

Gear Ratio		PTO	Rotor
A	B	R.p.m.	R.p.m.
21	18	540	277
20	19	540	250
19	20	540	226
18	21	540	204

LEVEL OF NOISE RESULT WHEN IDLING

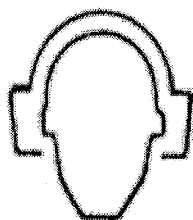

L_{pa} (A) 83 dB MAX

ATTACHING THE MACHINE TO THE TRACTOR



The machines described in this manual do apply to any kind of tractor provided of universal third hitch point.

The characteristics (length, diameter of the holes for the lifting pins) of the tractor's lifting arms depend on the type of tractor utilized, therefore it is necessary to prepare the machine in order to conclude the attachment correctly.

Before attaching the machine to the tractor you must be sure that the engine is shut off, brakes are locked and the ignition key is removed.

This operation must be made on a flat area as it is very dangerous.



Do not allow anyone between tractor and the machine when the engine is running.

Follow these instructions:

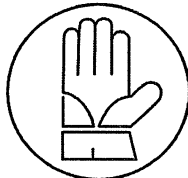

Connect the hitch of the drawbar to the tractor using a hitch pin and the hair clip pin (see fig. 1).

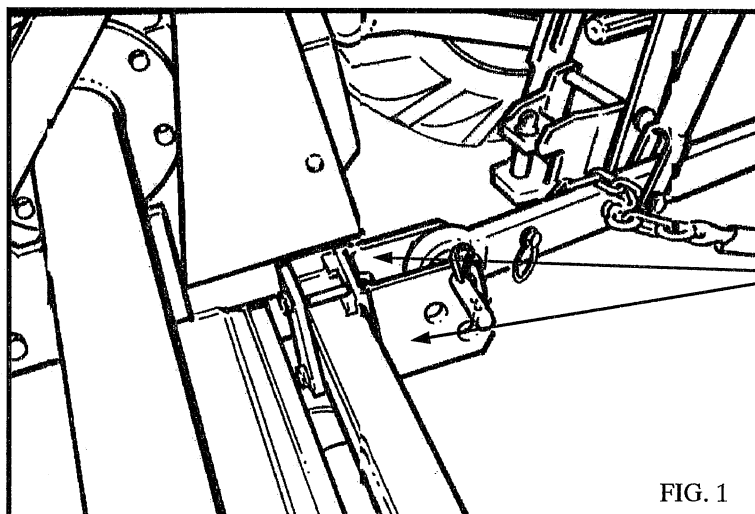

LOWER
PLATES

FIG. 1



Connect the third point of the tractor to the upper plates of the machine using a hitch pin and the hair clip pin (see fig. 2). By means of the tie rod of the hitch point, which permits regulation of the machine's inclination, set the machine even to ground-floor (see fig. 3). This procedure extends life time of the PTO shaft and the machine.

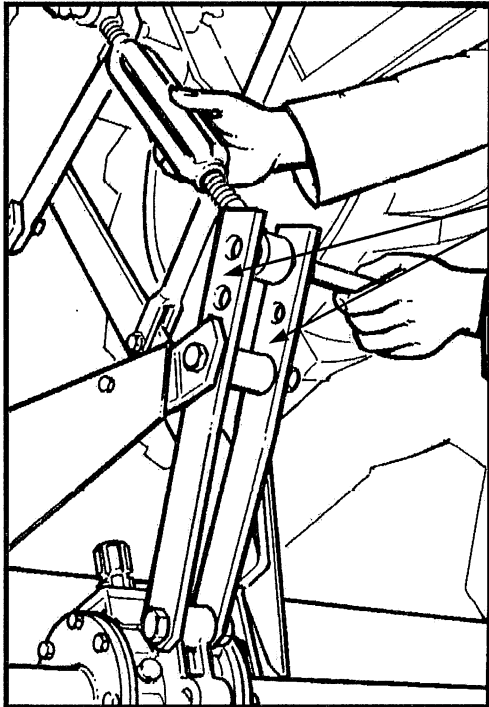

UPPER TIE
RODS

FIG. 2

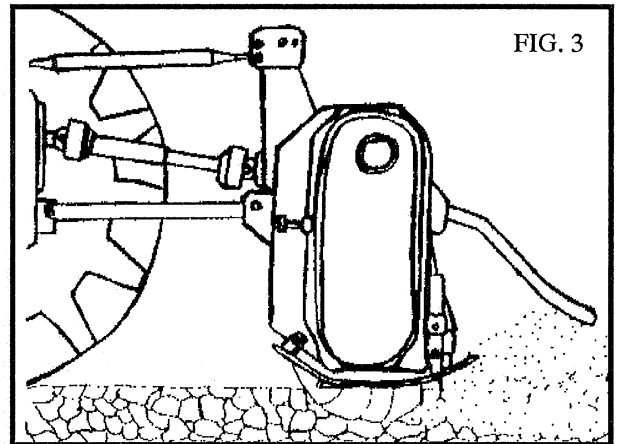

FIG. 3



Connect the PTO shaft and be sure it is correctly connected to the tractor and machine.

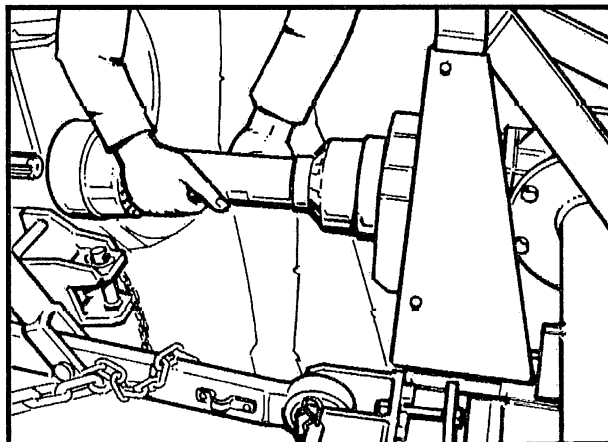
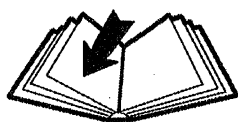

FIG. 4

Shortening the PTO shaft

Due to the many different types of tractors, it may be necessary to shorten the PTO shaft.



Always refer to the manual of the driveline's manufactures. Read it carefully.



In case shortening is needed, listed below are some basic guidelines on performing this modification. Determine how much length is to be removed, then:

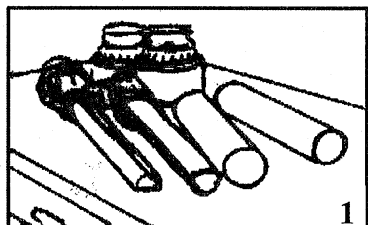
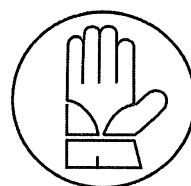

1) Remove plastic protection (both sections)

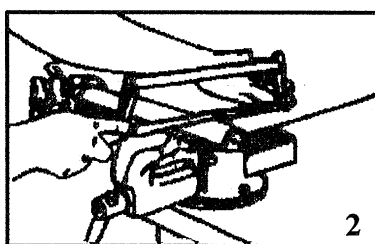

2) Cut the excess length of both tubes

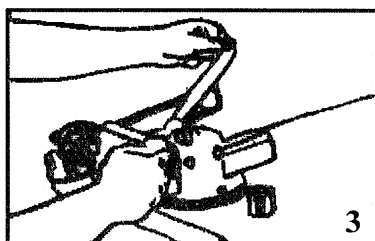

3) Deburr and clean the saw-dust off ends of tubes. Remove packing inside shaft tubing

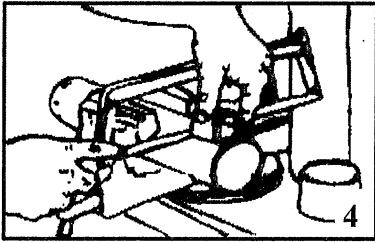

-  4) Cut the plastic protection to the same length you have cut the joints

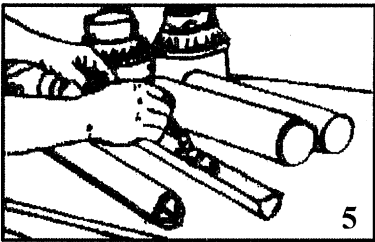

-  5) Grease the male joint section and reassemble protection



Do not use PTO shafts without proper shielding installed.

DEPTH CONTROL



To set the machine's working depth, adjust the two lateral skids as in figure 1:

- Loosen screw "a".
- Unscrew screw "b".
- Adjust the skid as wished screwing down screw "b" in one of the holes located in the same skid.
- Adjust screw "a".

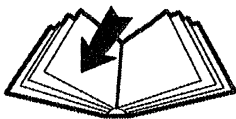
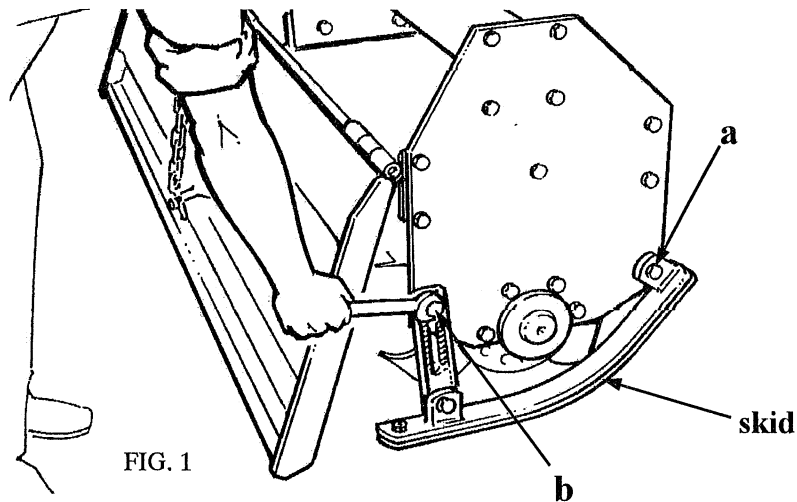

To get on even soil, make sure that both skids are at the same position.



If your machine is equipped with a rear roller, depth adjustment is carried out by a crank (fig. 2).

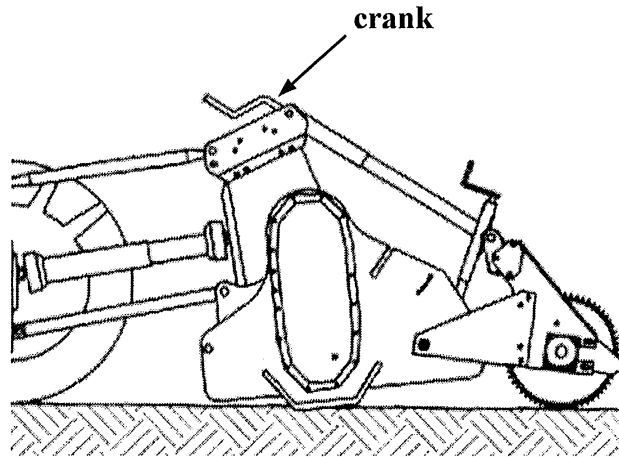

FIG. 2

CHAIN TENSION ADJUSTMENT

Chain tension check has been made before the delivery of your machine. Please follow next steps when you adjust the chain (fig. 3):

- Loosen lock nut "c".
- Tighten screw "d" as much as necessary. When you feel slight resistance, the chain tension is set.
- Then tighten lock nut which locks the adjustment screw in place.

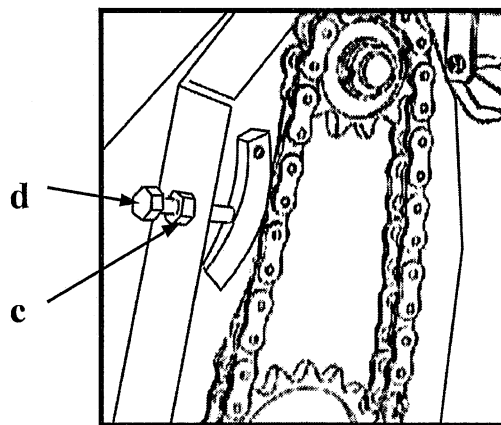

FIG. 3



Excessive chain tension can damage the machine.



GEAR SPEED— REC-2 Series

These machines are equipped with a 4 speed gearbox, which permits to change the rotor speed.

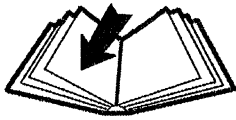

Higher rotor speed allows better tilling of the soil.



To change speed you must follow next steps:

- Pay attention: oil can come out, so position the machine in a way that rear part is higher than front part.
- Unscrew its bolts and remove the rear cover of the gearbox.
- According to the required speed, change position of the gears (See chart in chapter on Technical Specifications).
- Mount again the rear cover and screw the bolts.

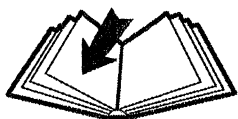

Be very careful and ensure to use the right gears, since some gear pairs cannot be inverted, and gears from different pairs cannot be interchanged. Use only original gears!

BEGINNING WORK

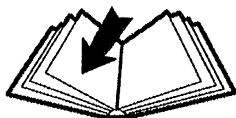

After completing all safety controls, to avoid damage start as follows:

- Raise the machine off the ground in order to let the blades start moving without touching ground.
- Maintaining the machine raised, engage the tractor PTO at suggested engine RPM.
- Start moving the tractor forward and then gradually lower the machine.

TIPS TO GET DESIRED RESULTS



Proper ground speed of the machine depends on the type of terrain to work. However it is advisable not to exceed 5 Km/h.

For a very fine seedbed, lower the rear shield completely and operate at a very slow speed. For a more coarse seedbed, raise the shield and/or increase operating speed, not exceeding the speed suggested before.



While operating, to avoid damage do not attempt to make turns and do not absolutely go backwards. Disengage the machine and raise it off the ground when making turns and U turns.

TROUBLE SHOOTING

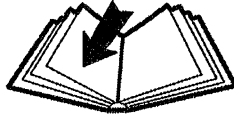

During work several problems can happen:

Unusual noise

While working, if the **machine** made **unusual noise**, the operator must **stop it immediately** and follow next instructions:

- **Check for broken/bent parts.**
- **Check for a sudden movement of the lateral cover after a casual impact.**

In fact, a sudden impact with an obstacle can move the cover out of place causing oil leaking. This can make the chain not be correctly lubricated and become noisy, and with time brake apart.

- **Check for correct oil level in the gearbox.**

When present incorrect oil level (see chapter on maintenance), the gears of the gearbox are not lubricated correctly, and if continue to rotate, would determine a significant **increase in oil temperature**. If continue working in this condition **will quickly take to damage gear bearings**.

- **Check condition of rotor support bearings.**

Inadequate lubrication (see chapter on maintenance) may cause damage on one of the two rotor support bearings. The rotor begins to oscillate causing excessive vibration to the frame and in short time, the damage of its weldings.

Another possible cause for bearing damage is the improper use of the machine: high ground speed, turns/U turns, going backwards, or operating in soil with high rock content.

Problem with uniformity on result

While operating, if you notice that work is not uniform, stop the machine and check that **no object has been trapped** in the rotor.



Before checking the machine to find the possible cause of the problem, be sure the tractor's PTO is disconnected, tractor's engine turned off, brakes on, key ignition off the command board, and the machine completely lowered to the ground.

DISCONNECTING THE MACHINE FROM THE TRACTOR



Disconnection of the machine must be carried out on flat area, and it is considered a very dangerous operation. You must pay attention. Follow these instructions:

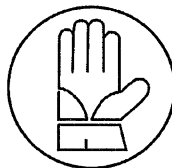

While remaining in the tractor seat, put the tractor PTO in neutral.



When rotors are completely stopped, turn off the engine and set the parking brakes.



Remove the ignition key.



Descend from the tractor and disconnect the driveline.



If you have an hydraulic fold machine, disconnect hydraulic hoses from the tractor.



Engage the parking stand.



Disconnect the hitch of the drawbar from the tractor.



Before disconnecting the driveline, be sure the tractor PTO is in neutral and engine is off.

STORING OF THE MACHINE

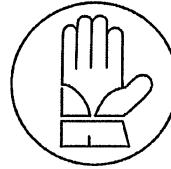
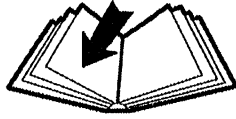

As your machine is an investment and if remains unused for a long period, we suggest the following procedures:

- Wash and dry the machine.
- Check all moving parts; for excessive wear replace the parts or contact your local dealer.
- Check bolts and nuts for proper tightness.
- Lubricate all the active parts like bearings, all grease zerk locations and other pivot or worn points that may not have a fitting.
- Lubricate all not-painted parts.
- Store the machine in a clean and dry place under roof.

MAINTENANCE

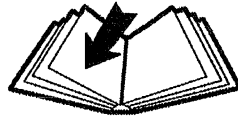

For long life of your machine and trouble free operation, regular program of maintenance is required.

The recommended phases of maintenance are for normal use and can be varied depending on the different conditions.



Always disengage tractor PTO before starting maintenance.



Every 10 working hours

- Check for loose bolts that fix the blades to the rotor. Tighten as needed (see fig. 1).
- Grease the PTO shaft components.
- Clean the end of PTO shaft with non toxic / non inflammable detergent.
- Be sure that driveline shields are in place and in good condition.
- Grease the right lateral support of the rotor (see fig. 2) after cleaning correctly the grease nipples for better lubrication. Use lithium type grease NLGI 2 .
- Clean the machine.

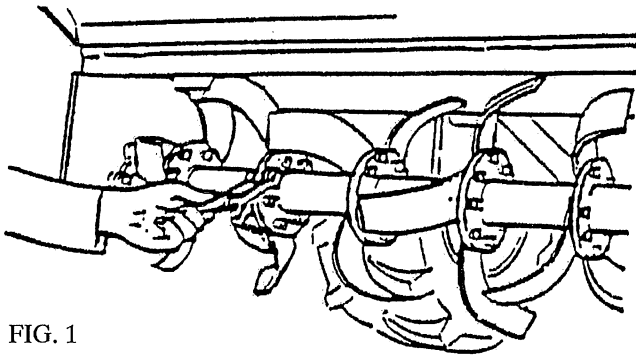

FIG. 1

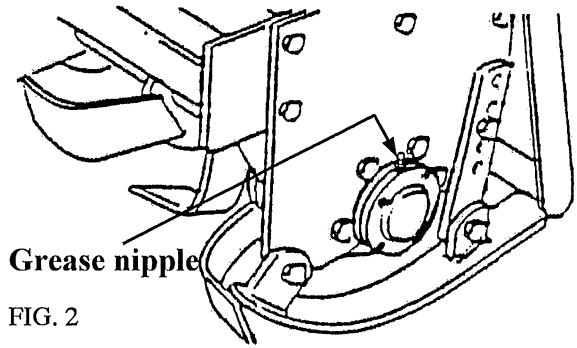

FIG. 2

Every 50 working hours

- Check blades for wear. Replace if necessary. Use only original parts.
- Make sure PTO shaft and slip clutch are in place and in good condition. If damaged or worn, replace slip discs. Contact your local dealer for substitution.
- Regulate chain tensioning.
- For those machines supplied with rear roller, grease the screw and lateral supports, after cleaning correctly the grease nipples for better lubrication. Use lithium type grease NLGI 2.
- Check oil level in the gearbox.

For versions (RE2-CRE2 and REC2-CREC2), this operation is carried out by unscrewing the plug located on top of the box (1 in fig. 3) and checking the oil measurer supplied with the plug. Correct oil level is when oil covers half of the measurer.

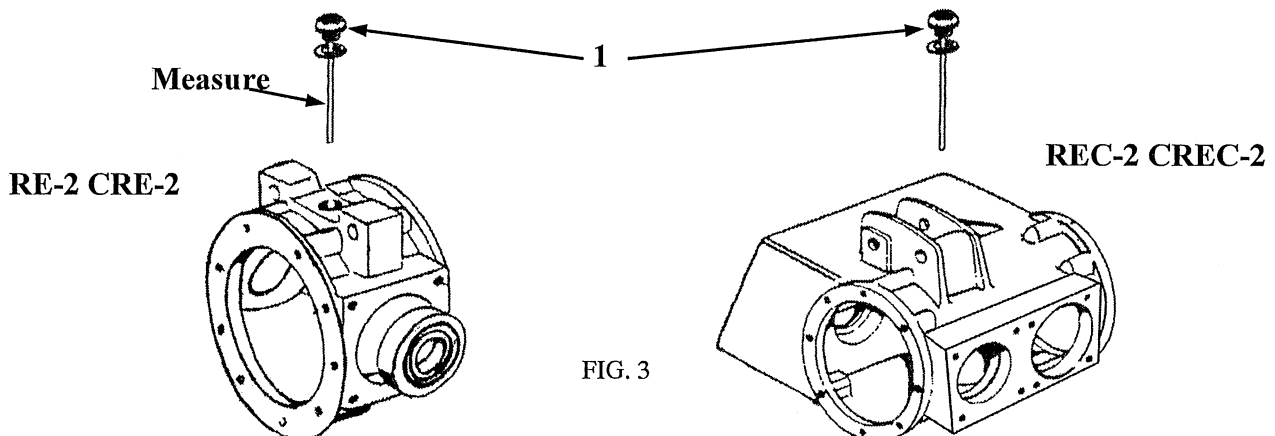
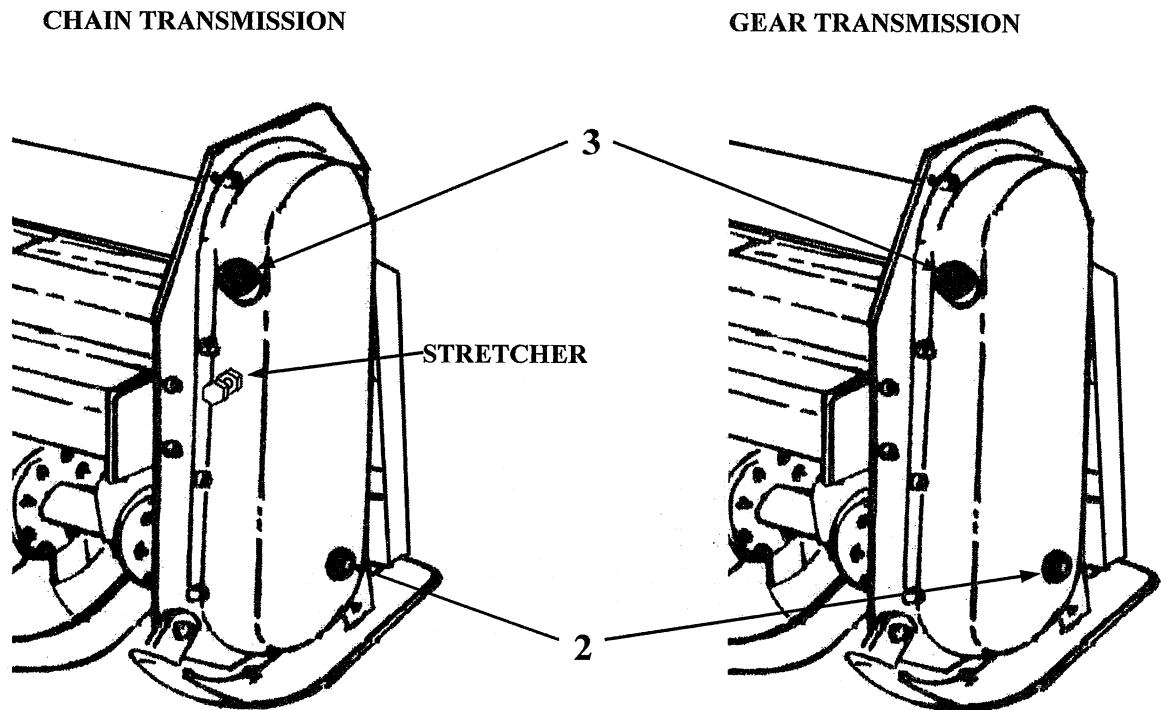

FIG. 3

- Check oil level in the cover (chain or gear transmission) by unscrewing the oil level plug (2 in fig. 4). If needed to add oil, unscrew the filler plug (3 in fig. 4) and fill in the cover until oil starts running out of the level hole.



First 100 working hours

- In the case the machine has done its first 100 hours, change oil in the gearbox and chain (gear) drive.

To change oil in the gearbox, unscrew the plug located on top of the box inclining opportunely the machine.

To change oil in the cover, drain all the oil from the level hole located on the lower part of it (always after inclining the machine).

These changes are necessary because the gears are new and so are subject to quicker worn.
Use oil: SAE 80 W 90 API GL 4.

Every 300 working hours

- Completely replace oil in the gearbox and chain drive, as explained before. Use oil: SAE 80 W 90 API GL 4.

TOXICOLOGICAL INFORMATION ABOUT LUBRICANTS



	TYPES OF DANGER	PROTECTIVE EQUIPMENT	PRIMARY INTERVENTION
SKIN	Possible irritation after prolonged contact	Gloves and/or lotion barrier	Wash with soap & water
EYES	Possible irritation on contact	Protective goggles	Rinse thoroughly w/ running water
INHALATION	Possible irritation after prolonged exposure	Maintain an oil mist level of 5mg/m ³ between TLV-TWA limits	Expose to fresh air and call medical assistance immediately
INGESTION	Such possibility not considered		DO NOT provoke vomiting; call medical assistance immediately

LIMITED WARRANTY POLICY



SOVEMA S.p.A., Manufacturer of quality machinery, guarantees new Sovema machinery from the time of delivery to the original purchaser to be free from defects in material and workmanship if properly set up and operated in accordance with recommendations set forth in SOVEMA's operator manual. SOVEMA's liability for any defect of accepted goods shall be limited to replacing them, or as SOVEMA shall elect.

The original purchaser will qualify for the SOVEMA warranty only after they have completed the warranty card in full and forwarded it to SOVEMA S.p.A. Italy or any SOVEMA branch.

SOVEMA's obligation shall terminate 12 (twelve) months after the date of purchase of the product by the original purchaser. This warranty cannot be assigned or transferred to anyone unless SOVEMA's consent in writing has first been obtained. All warranty claims must be forwarded to SOVEMA S.p.A. Italy or a SOVEMA branch within 8 (eight) days after occurrence.

The original purchaser will be responsible for and bear costs of:

- A) Normal maintenance such as greasing, maintenance of oil levels, minor adjustments, etc.
- B) Transportation of any kind of, any SOVEMA product to and from the place where warranty work is performed.

This warranty shall not apply to any machine which has been repaired or altered in any way outside the SOVEMA factory which affects its stability or reliability, nor which has been subject to misuse, negligence or accident, nor to any machine that has not been operated in accordance with SOVEMA's printed instructions, or operated beyond the company recommended capacity as per machine.

This warranty shall not be applicable to items which are subject to the warranties of their respective manufacturers. Such items would include but would not be limited to clutches, universal joints, knives, hydraulic components, bearings, tires, belts and other trade accessories.

This warranty shall not be applicable to items defined as normal wearing items. Such items would include but would not be limited to belts, discs, knives, tines stone guards, tires, slip clutches, pitman shaft, swath sticks, blades or tine holders.

The judgement of SOVEMA S.p.A. in all cases of claims under this warranty shall be final and conclusive and the original purchaser agrees to accept its decisions about all questions as to defects and/or to the exchange of any part or parts.

No Agent, Employee or Representative of SOVEMA has any authority to bind SOVEMA to any affirmation, representation or warranty, concerning its machinery excepts as specifically set forth.

SOVEMA shall not be liable for special or consequential damages of any kind caused by any

SOVEMA S.p.A.
 Via Olmo, 6-8-10
 41010 Gaggio di Piano (MO)
 Italy



Telefono: 059 93 85 85
 Fax : 059 93 85 12
 E-mail : sovema@sovema.com
 Web site: www.sovema.com

WARRANTY REGISTRATION

This warranty will become valid only if this form is completed and signed by both the Purchaser and the Dealer and is returned within 8 days of purchase date! **IF NOT WARRANTY IS INVALID.**

TO FILL OUT

- ❖ *TYPE OF IMPLEMENT* : _____
- ❖ *IMPLEMENT SERIAL NUMBER* : _____
- ❖ *DATE OF PURCHASE* : _____

<p>DEALER: I HEREBY CERTIFY THAT</p> <ul style="list-style-type: none"> The machine has been correctly assembled in accordance with the manufacturers instructions. All nuts and bolts, oil level and grease have been checked. All safety guards and warning stickers have been placed on machine. PTO has been matched to tractor and greased. All other pre-delivery checks have been completed as per operators manual. Purchaser was given operators manual and instructed in safe and correct usage of machine and on limitation of warranty. Machine was tested and operates correctly. 	<p>PURCHASER: I HEREBY ACCEPT</p> <ul style="list-style-type: none"> That the machine is correctly assembled. Receipt of the operators manual which I have read and have clearly understood.. To have a clear understanding of the warranty limitations. To have a clear understanding of the correct and safe operation of the machine. That the machine need regular maintenance as instructions in operators manual. To have clear understanding on the capacity of this machine and made aware of its limitations.
--	---

<p style="text-align: center;">(address)</p> <p>_____</p> <p>_____</p> <p>_____</p> <p>Date: _____ Signature: _____</p> <p style="writing-mode: vertical-rl; transform: rotate(180deg);">DEALER</p>	<p style="text-align: center;">(address)</p> <p>_____</p> <p>_____</p> <p>_____</p> <p>Date: _____ Signature: _____</p> <p style="writing-mode: vertical-rl; transform: rotate(180deg);">PURCHASER</p>
--	---

COPY TO DELIVER TO: SOVEMA

SOVEMA S.p.A.
 Via Olmo, 6-8-10
 41010 Gaggio di Piano (MO)
 Italy



Telefono: 059 93 85 85
 Fax : 059 93 85 12
 E-mail : sovema@sovema.com
 Web site: www.sovema.com

WARRANTY REGISTRATION

This warranty will become valid only if this form is completed and signed by both the Purchaser and the Dealer and is returned within 8 days of purchase date! **IF NOT WARRANTY IS INVALID.**

TO FILL OUT

- ❖ *TYPE OF IMPLEMENT* : _____
- ❖ *IMPLEMENT SERIAL NUMBER* : _____
- ❖ *DATE OF PURCHASE* : _____

<p>DEALER: I HEREBY CERTIFY THAT</p> <ul style="list-style-type: none"> The machine has been correctly assembled in accordance with the manufacturers instructions. All nuts and bolts, oil level and grease have been checked. All safety guards and warning stickers have been placed on machine. PTO has been matched to tractor and greased. All other pre-delivery checks have been completed as per operators manual. Purchaser was given operators manual and instructed in safe and correct usage of machine and on limitation of warranty. Machine was tested and operates correctly. 	<p>PURCHASER: I HEREBY ACCEPT</p> <ul style="list-style-type: none"> That the machine is correctly assembled. Receipt of the operators manual which I have read and have clearly understood.. To have a clear understanding of the warranty limitations. To have a clear understanding of the correct and safe operation of the machine. That the machine need regular maintenance as instructions in operators manual. To have clear understanding on the capacity of this machine and made aware of its limitations.
--	---

<p style="text-align: center;">(address)</p> <p>DEALER</p> <p>_____</p> <p>_____</p> <p>_____</p> <p>Date: _____ Signature: _____</p>	<p style="text-align: center;">(address)</p> <p>PURCHASER</p> <p>_____</p> <p>_____</p> <p>_____</p> <p>Date: _____ Signature: _____</p>
--	---

PURCHASER COPY

SOVEMA Product Line

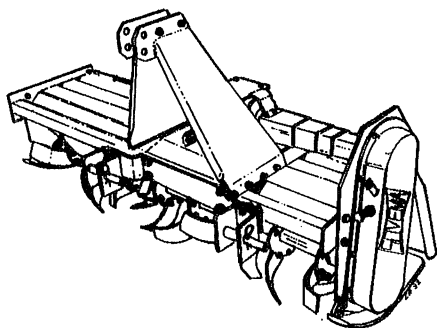

SIDE SHIFT ROTARY TILLERS

- 15 different models;
- For tractors from 12 to 70 HP
- Working width from 80 to 200 cm.

FIXED ROTARY TILLERS

- Over 45 different models;
- For tractors from 15 to 130 HP
- Working width from 80 to 300 cm.

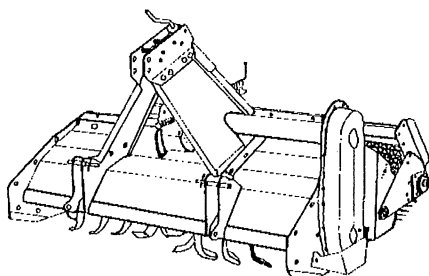
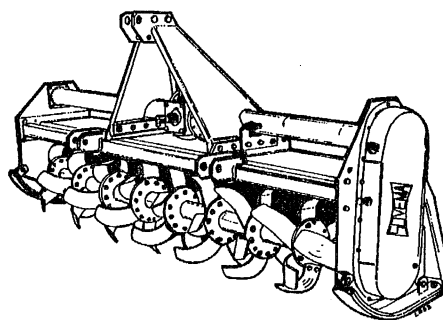

STONE BURRIERS

- 6 different models;
- For tractors from 35 to 90 HP
- Working width from 100 to 200 cm.

ROTARY HARROWS

- 13 different models;
- For tractors from 25 to 150 HP
- Working width from 110 to 500 cm.

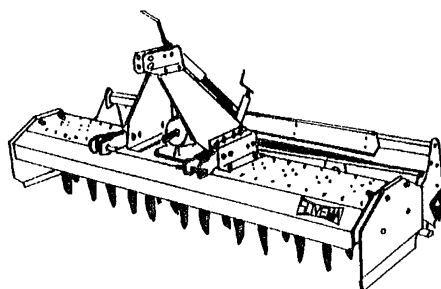

ROTARY DITCHERS

- 10 different models;
- For tractors from 40 to 130 HP
- Working depth from 45 to 110 cm.

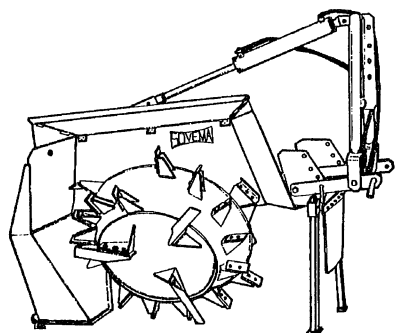

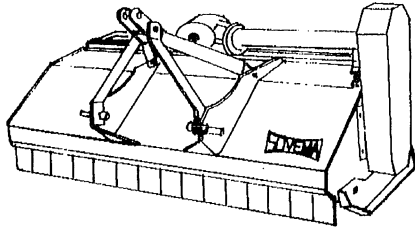

FLAIL MOWERS - SHREDDERS

- 35 different models;
- For tractors from 15 to 120 HP
- Working width from 100 to 470 cm.

MOWERS COLLECTOR

- 6 different models;
- For tractors from 30 to 60 HP
- Working width from 120 to 180 cm.
- Available with high discharge and low discharge

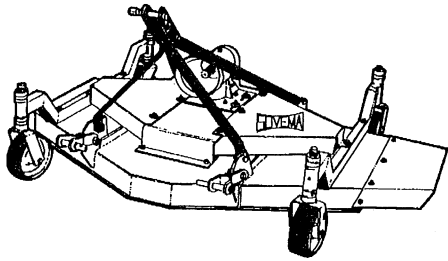
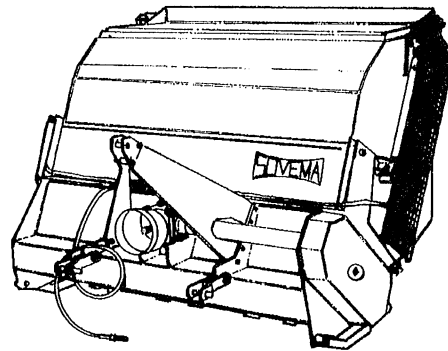

FINISHING MOWERS

- 14 different models;
- For tractors from 15 to 70 HP
- Working width from 100 to 300 cm.

HYDRAULIC FORK-LIFTS

- 11 different models;
- For tractors up to 60 HP
- Lifting capacity from 1.300 Kg to 2.000 Kg.

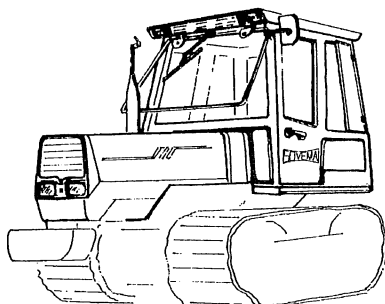
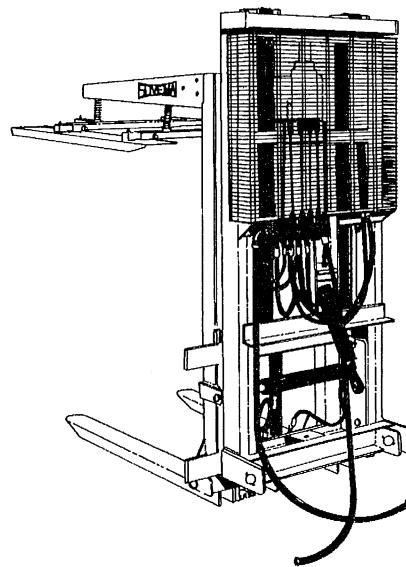

TRACTOR CABS

- Over twenty models of cabs for eleven manufacturers of tractors;
- For tractors with wheels or crawlers;
- All models available with heating and/or air conditioned.

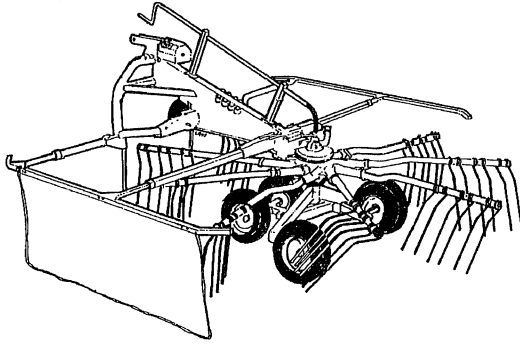

ROTARY RAKE

- 4 different models
- For tractors from 30 to 70 HP
- Working width from 340 to 695 cm.

HAY TEDDERS

- 6 different models (2, 4, 6 rotors)
- For tractors from 10 to 40 HP
- Working width from 310 to 730 cm.

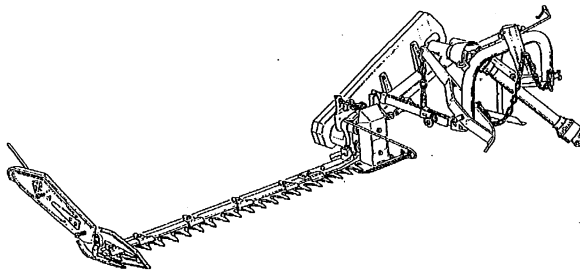
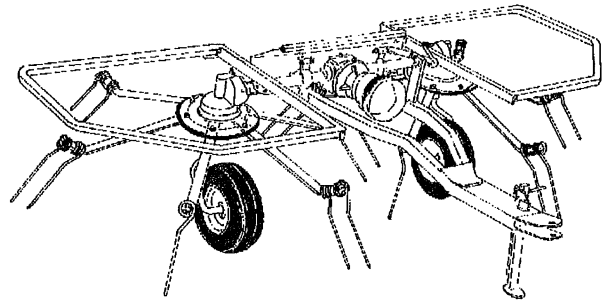

SICKLE BAR MOWER

- 3 different models.
- For tractors from 10 to 15 HP.

FINGER WHEELS

- 8 different models (8-20 stars)
- For tractors from 30 to 80 HP
- Working width from 7.35 to 12.50 m.

